

Experimental Study of Tsunami Bore Induced Forces on Vertical Seawall

Zaty Aktar Mokhtar ^{1*}, Badronnisa Yusuf ¹, Thamer Ahmad Mohammed ² and Saiful Bahri Hamzah ³

¹ Department of Civil Engineering, Faculty of Engineering, Universiti Putra Malaysia, 43400 UPM, Serdang, Selangor, Malaysia

² Department of Water Resources, College of Engineering, University of Baghdad, Iraq

³ Hydraulic and Instrumentation Laboratory, National Hydraulic Research Institute of Malaysia, Seri Kembangan, Malaysia

ABSTRACT

Field surveys of the 2011 Tohoku Tsunami reported massive failures of many seawalls and coastal barriers. The massive damages are vivid evidence that there are flaws in the design of seawalls and barriers. With this as the background, a sequence of laboratory experiments using dam-break waves was performed to simulate the interactions between the tsunami-like bore flow and vertical seawall as well as to measure the bore-induced pressures and to estimate forces exerted on the vertical seawall model. The experimental result revealed that the maximum pressure (approximately 8 kPa) exerted on the vertical seawall was measured at the lowest pressure sensor location. Experimental data were used to

re-examine the relevant empirical formulae found in the literature. The obtained results could be useful for calibrating mathematical and numerical models as well as for future research concerning the design of tsunami barriers.

ARTICLE INFO

Article history:

Received: 22 June 2018

Accepted: 6 December 2018

Published: 25 April 2019

E-mail addresses:

ety_nabila@yahoo.com (Zaty Aktar Mokhtar)

nisa@upm.edu.my (Badronnisa Yusuf)

tthamer@gmail.com (Thamer Ahmad Mohammed)

desmodeci@gmail.com (Saiful Bahri Hamzah)

* Corresponding author

Keywords: Dam-break wave, force, physical model, tsunami bore, vertical seawall

INTRODUCTION

In some coastal areas, seawalls are intended to protect the coasts from potentially massive hazards such as storm surges and tsunamis. Thus, most critical counter measures for instance seawalls, breakwaters and dykes are crucial and become one of the mitigating measures for protection of life and property against such extreme waves.

However, a catastrophic damage of many sea defence structures was observed along the shoreline areas after the occurrence of the 2011 Tohoku tsunami. The mechanisms behind the failure of many seawalls and coastal barriers due to the tsunami are still being investigated and have not yet been fully elucidated thus far. Evidence from the 2011 Tohoku Tsunami video footages shown that a visible white foam strip coming towards the shore, which is known to be tsunami bores.

Over the past few decades, there have been several studies on the interaction of tsunami-like solitary wave with seawall and their impacts (Hamzah et al., 2000; Kato et al., 2006; Hsiao & Lin, 2010; Lin et al., 2012). Nevertheless, forces study resulting from tsunami bores hitting onshore seawalls using the dam-break flow to simulate a tsunami bore is less explored. Chanson (2006) demonstrated that a dam-break flow could exhibit a reasonable simulation of the tsunami-induced bore.

Cross (1967) carried out an experimental study to investigate the properties of incident bores and surges advancing into still water and dry bed as well as their impact forces on a vertical wall. He proposed the tsunami force exerted on the vertical wall could be estimated using the following equation:

$$F = \frac{1}{2} \rho g h_b^2 + \rho h_b u_b^2 \quad [1]$$

where ρ is the mass density, g is the gravitational acceleration, h_b is the height of the bore from the ground level (bore depth), u_b is the bore velocity.

Asakura et al. (2000) measured forces exerted on an onshore vertical structure that was located on a dry bed and proposed the following empirical equation to estimate the force exerted on the vertical wall:

$$F = \frac{1}{2} \rho g (3h)^2 \quad [2]$$

where h is the bore height (height of the bore from the still water). Fujima et al. (2009) performed experimental studies to investigate wave force exerted on rectangular onshore structures subjected to tsunami breaking bore. A measured total force obtained from their experiments was used to formulate the tsunami force estimation equation that was based on the maximum inundation depth and the distance of structure from the shoreline. The equation is expressed as follows:

$$F = 1.3\rho hu_b^2 \quad [3]$$

The Overseas Coastal Area Development Institute (OCDI) of the Ports and Harbours Bureau of Japan (2009) suggested that the tsunami force per unit width on an upright wall (when the tsunami is a bore-type) could be estimated using the following equation:

$$F = 3.3\rho gh^2 + 2.2 \rho gh d_s \quad [4]$$

Robertson et al. (2013) conducted large-scale hydraulic tests to study the tsunami-induced forces and pressures exerted on a vertical wall. They investigated the impact forces of tsunami bore advancing over both dry and wet bed reefs which generated from a broken solitary wave and proposed the following force estimation equation on the vertical wall:

$$F = \frac{1}{2}\rho gh_b^2 + \rho hu_b^2 + \rho g^{1/3} (hu_b)^{4/3} \quad [5]$$

In this study, forces exerted on vertical seawall were calculated from the measured pressures obtained by Zaty et al. (2019). The bore that was generated using a dam-break method propagated over the wet flume bed before hitting the structure model.

RESEARCH METHOD

Experimental Setup

The experiments were performed at the Hydraulics Laboratory of the National Hydraulic Research Institute of Malaysia (NAHRIM), Selangor. The test flume was 100 m x 1.5 m x 2.0 m (length x width x height). The concrete flume was partitioned into two sections in order to create an upstream reservoir area of 44 m long and the downstream test area as shown in Figure 1. In this study, the dam-break flow was used to simulate tsunami bore. A steel sluice gate was installed between the upstream reservoir and the test section area. The gate was lifted rapidly to release the water from the reservoir to generate tsunami-like bore in the downstream flume test area. The simulated tsunami bore travelled on the wet flume bed with a still water depth (d_s) of 0.05 m in all experimental cases.

Model Details

A model scale of 1:10 was adopted in this study. The test model used in this research is a vertical-front type seawall model (hereafter VW). The seawall model was installed on the horizontal flume bed at 9.0 m downstream from the gate in the flume test area and rigidly bolted to the floor. The 0.5 m high seawall model structure was constructed from 10 mm thick acrylic sheet. The transverse length of the seawall was extended across the entire

width of the flume. To provide sufficient rigidity to the seawall model during bore impacts, steel frames were fixed at the rear of the model as a support.

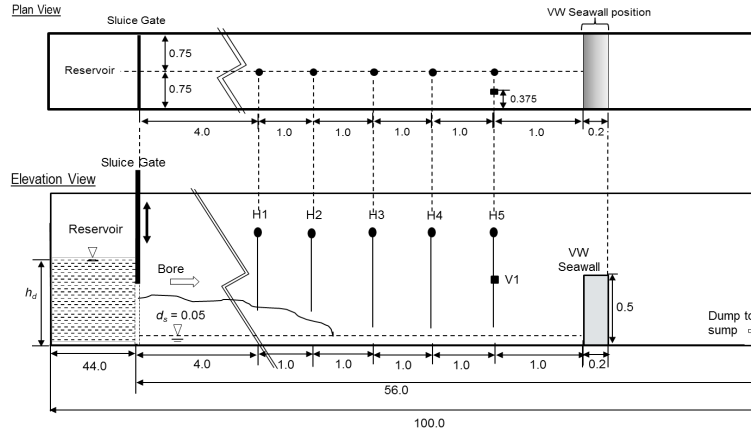

Figure 1. Plan and elevation views showing the location of VW seawall, wave gauges (H1-H5) and velocimeter (V1) in the test flume. All dimensions are in meters and not to scale.

Instrumentation

Five resistance wave gauges (H1 to H5) were installed along the downstream flume test area to measure the bore elevations during the experiments. The wave gauges were mounted onto a frame located on top of the flume which consisted of several steel pipes installed across the longitudinal axis of the flume. Each wave gauge was located at 1.0 m apart. An Acoustic Doppler Velocimeter (ADV, Nortek), V1 was used to measure the bore velocity that was co-located with wave gauge H5 in this study. Both V1 and H5 were located at 1.0 m upstream from the seawall model and 8.0 m downstream from the gate. In this study, three pressure sensors (Keller® PR-25Y) were used and were fixed flush against the upstream face of the seawall model at six different locations to record the time histories of pressures (Figure 2). However, due to the limited number of pressure sensors available during the tests, similar experiments were repeated several times by moving the sensors to different sensor hole positions on the front face of the VW model. The sensors (P1 to P6) were installed vertically at 70 mm intervals. The location of the pressure sensor ports on the seawall model is shown in Figure 3. The pressure sensors were logged at 1000 Hz, while the measured flow depths and velocity data were digitised with a sampling rate of 50 Hz. The flow depths and pressure data measurements were using the same data logging system (HR Wallingford Data AcQuisition software) and were synchronised to the same time. In this research, two digital cameras and a high-speed digital video camera that operated at a frame rate of 240 fps were utilised to film and qualitatively document the bore impacts processes.

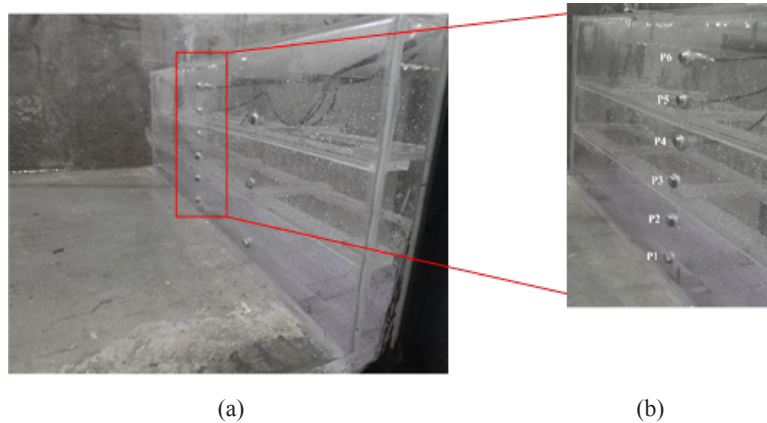

Figure 2. The view of (a) VW model in the flume, (b) pressure sensors position on the upstream face of VW model

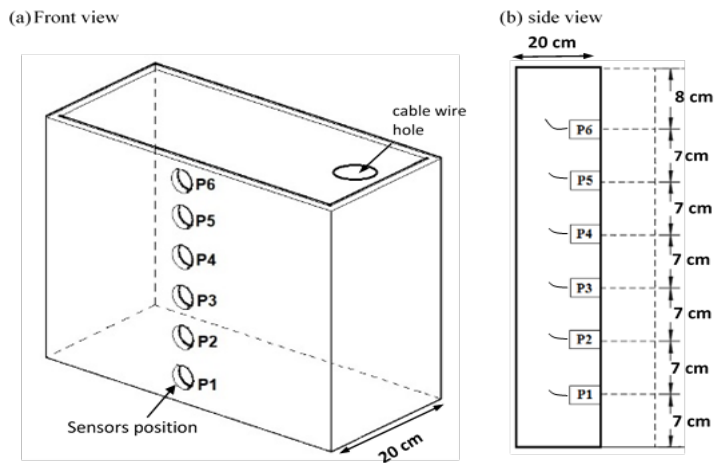

Figure 3. The location of the pressure sensors on the seawall

Experimental Conditions

In this study, five different combinations of impoundment water depths (h_d) and gate opening heights (GO) were used to produce five experimental bore cases with different bore depths (h_b) and bore velocities (u_b) as listed in Table 1. Each test was repeated at least three times to verify repeatability and to ensure the reliability of the results. The repeatability of all tests was less than 5% between repetitions and demonstrated good repeatability.

RESULTS AND DISCUSSION

Bore Depth–Velocity Relationship

In this study, various tsunami bore heights and velocities (Table 1) were generated in the

flume from a dam-break method (Chanson, 2006). A typical time history of bore depth and bore velocity for the bore generated from 0.7 m impoundment water depth measured at 1.0 m upstream from the seawall model is depicted in Figure 4.

As can be seen in Figure 4, it is observed that the water level rose rapidly at approximately $t = 5.0$ s. Measurement at H5 showed rapid increases in water level due to the bore reflection from the seawall, while at the same time the velocity decreases to negative values which indicated that the velocity was in the same direction as the reflected bore (negative x-direction).

Figure 5 shows snapshots of the bore impacting the VW model taken from the side of the wave flume during the experiment. The bore front (with air bubbles plumes can be seen entrapped at the bore front) hit the 0.5 m seawall model structure that was installed in the downstream flume test area and then the wave began to surge up on the front face of the VW model with a high water velocity together with a splash-up.

Table 1

Experimental cases in the study

Case	Impoundment water depth (h_d), m	Gate Opening (GO), m	Bore depth (h_b), m	Bore velocity (u_b), m/s	Maximum Bore Force (N)
Case 1	0.55	0.3	0.218	1.98	1726.0
Case 2	0.60	0.5	0.226	2.29	1952.3
Case 3	0.65	0.3	0.243	2.39	2305.4
Case 4	0.70	0.5	0.257	2.45	2533.1
Case 5	0.75	0.3	0.274	2.51	2744.0

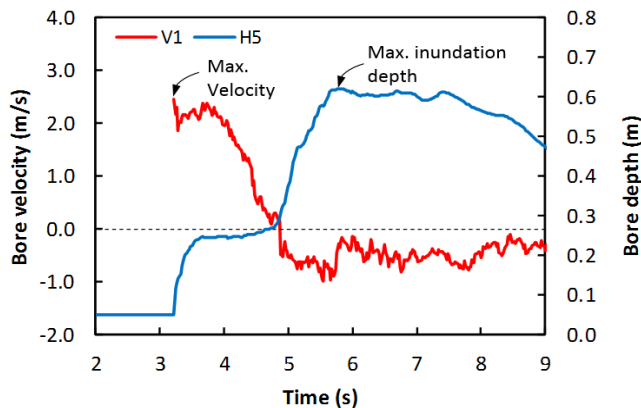

Figure 4. Example of the time histories record of changes in bore depth and velocity upstream from the model location for case 4

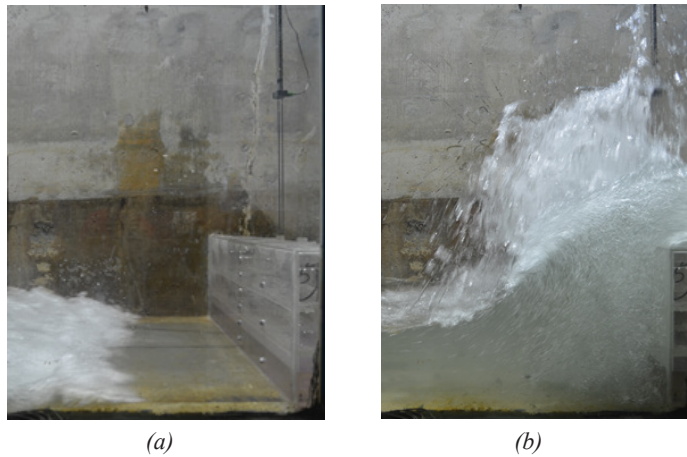

Figure 5 (a&b). The bore propagating over wet flume bed and hit the seawall model with water splashed-up

Bore-Induced Pressures and Forces Distribution on Seawall

The experiments were also performed to quantify the characteristics of bore-induced forces on the upstream face of the VW model and bore-induced pressures exerted on the wall. Figure 6 illustrates the variation of maximum wave pressures with respect to impoundment water depths recorded at each pressure sensor. From the figure, it can be concluded that there is a linear relationship between the maximum recorded pressure and impoundment depths. For all cases, it is noted that the highest pressure was observed at the lowest-located pressure sensor (P1), while the lowest pressures were measured at the highest-located pressure sensor (P6).

Figure 7 shows time histories of bore pressures recorded by different pressure sensor P1 to P6 located on the upstream face of the VW model (Case 4). High impulsive pressures (usually characterized by a short-duration pressure) were recorded by the lower-located pressure sensors (P1 and P2). It is found that the maximum pressure measured by the sensor nearest to the flume bed (at $z = 0.07$ m) was approximately 7 kPa. A similar trend was observed in the previous studies by Al-Faesly (2016), Kihara et al. (2015) and Nouri et al. (2010) where high impulsive pressures were measured at the lowest-located pressure sensor in their experimental case studies.

The vertical distribution of maximum bore pressures exerted on the VW model for all experimental cases are shown in Figure 8. As can be seen from the figure, the pressure measured by the sensors typically increased as bore height increased. It is also found that the maximum pressures decreased with height for each case in this study.

Figure 9 shows the calculated force from the integration of the measured pressure exerted on the VW model from bore generated by three impounding water depths of 0.75 m, 0.65 m and 0.55 m. For this analysis, the force acting on the VW model was obtained

by integrating pressure data along the seawall surface. The pressure integration method was previously used by Hsiao et al. (2010), Robertson et al. (2013) and Shafiei et al. (2016). The horizontal seawall surface was divided into strips and the exerted pressure was assumed to be constant.

In this study, a typical time history of bore-induced forces exerted on the seawall model are characterized by four phases: (1) impulsive force that occurs when bore front impacts the seawall (the force durations were in the range of 0.01 s - 0.05 s); (2) run-up force that occurs when bore begins to run-up the wall and bore depth increases in front of the wall; (3) as the water starts accumulating in front of the wall (since the wall extending across the entire of the flume width), the overflow occurs and a gradual decrease in the force is observed in the time-history; and finally (4) when the force distribution on the wall is approximately constant over a longer period during the quasi-steady phase. The second phase was usually characterised by significant pressure oscillations due to the high turbulence of bore flow, and the maximum force was recorded during this phase in the time history recording. Findings in this study were consistent with the previous study by Al-Faesly (2016).

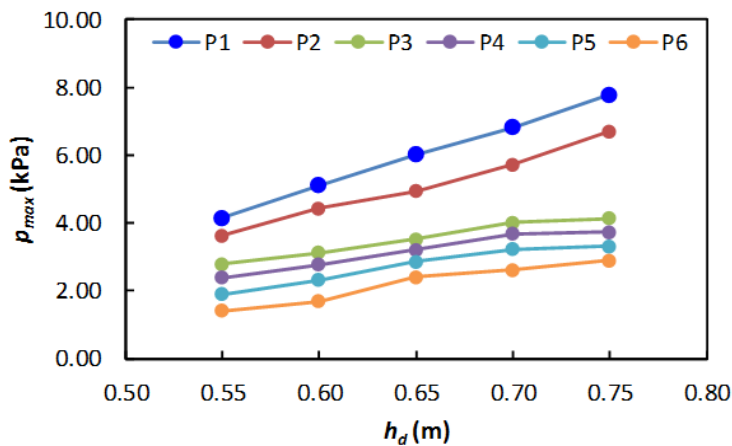

Figure 6. Variation of maximum wave pressures with respect to impoundment depths

Tsunami Force Estimation Equations

The comparison has been made between previous empirical formulas and the experimental data obtained in the present study to estimate bore impact force on the vertical wall. Figure 10 graphically shows the comparison of the maximum calculated bore impact force obtained from the present study with that calculated using previous formulas of Equations [1], [2], [3], [4] and [5]. From the results, the calculated forces from the integration of the measured pressure in the present study exhibit a similar inclination with Equation [2]

Tsunami Bore Forces on Vertical Seawall

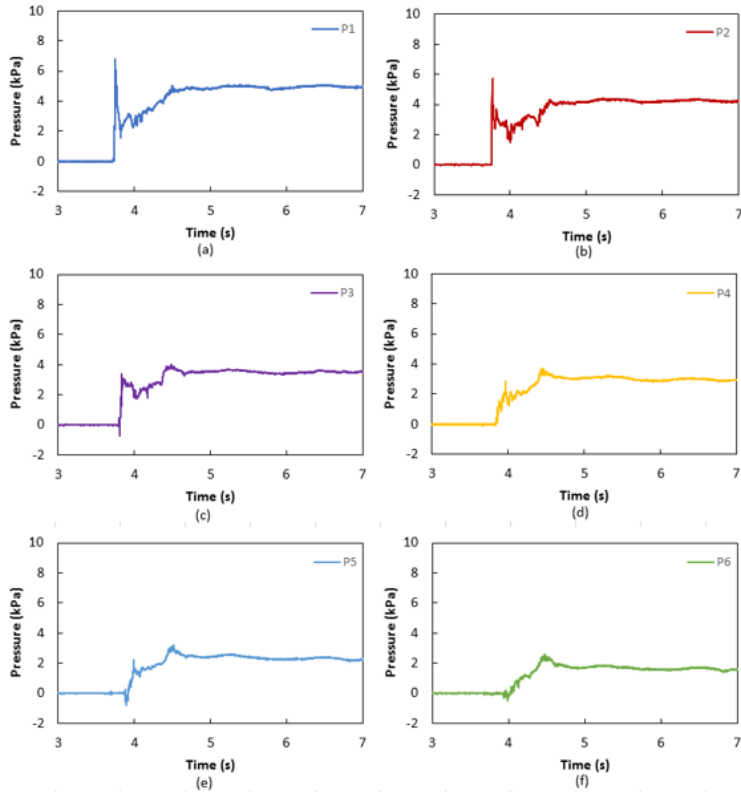

Figure 7. Bore pressure-time histories induced on the seawall model from bore generated by 0.7 m impounding water depth recorded at each pressure sensor

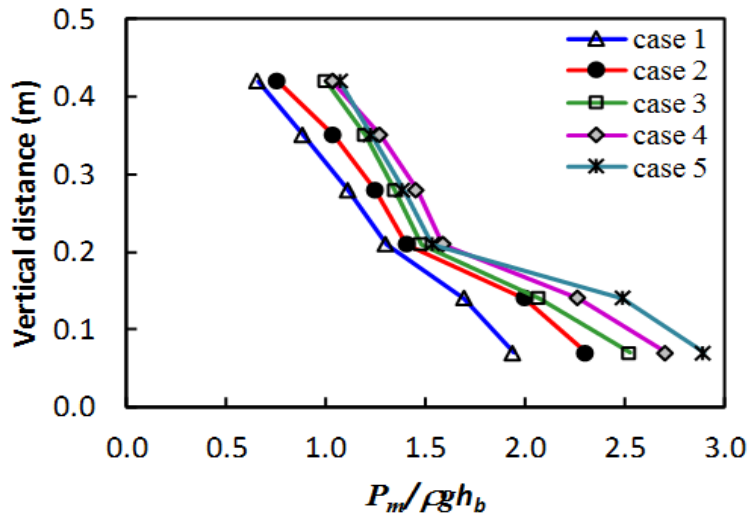

Figure 8. Vertical distribution of maximum bore-induced pressure on the upstream face of VW model for all cases

although the proposed equation underestimated the force. It is also noted that Equation [5] tends to overestimate the estimated bore force using the data of the present study. Figure 10 reveals that the models by Cross (1967), Fujima et al. (2009), and OCDI (2009) appeared in agreement with the model proposed in the present study. The high correlation coefficients determined from the regression analysis confirm the linear relationship between the maximum forces and bore depth.

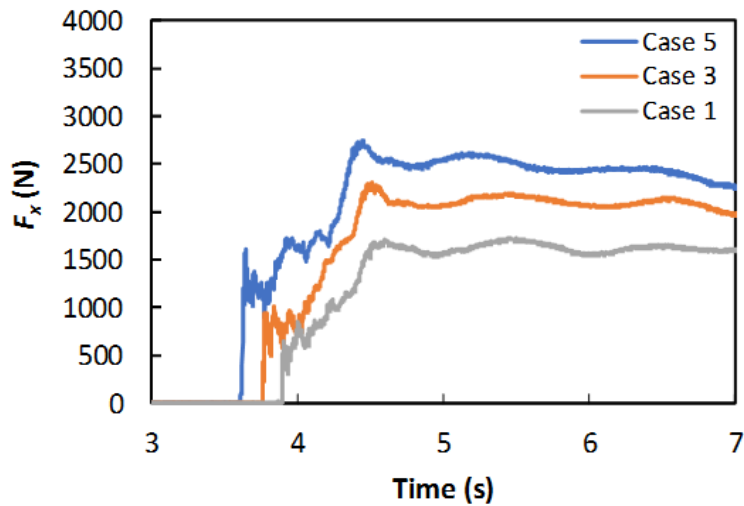

Figure 9. Computation of the bore force on the VW seawall model from bore generated by 0.75 m, 0.65 m and 0.55 m impounding water depths

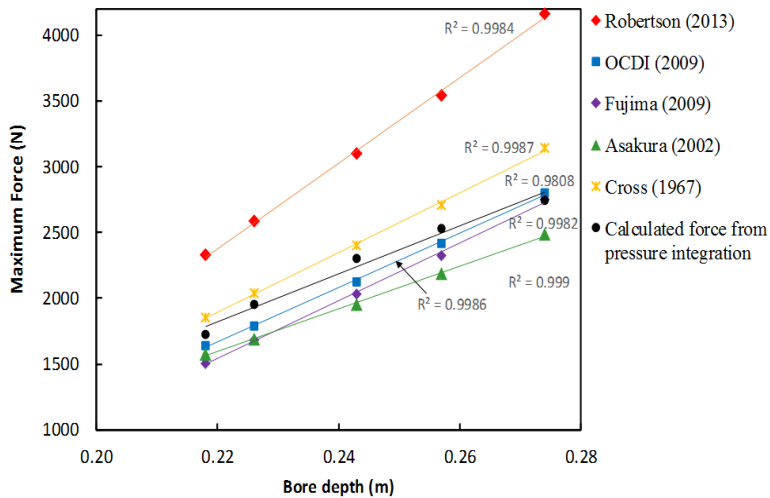

Figure 10. Comparison of maximum force of previous studies with the present study

DISCUSSION AND CONCLUSIONS

The 2004 Indian Ocean Tsunami, the 2011 Tohoku Tsunami and the recent 2018 Palu Sulawesi Tsunami have resulted in large number of casualties and huge economical loss. The occurrence of these events necessitates reviewing the designs of all costal defence structures including the design of seawalls. The failures of many seawalls during the 2011 Tohoku tsunami were practical cases indicated that seawalls cannot take the dynamic force due to tsunami bore. The present study was focused on conducting experiments on vertical seawall model that was subjected to dynamic force due to tsunami bore. In this study, the investigation on the characteristics of bore pressures and forces exerted on the vertical seawall was carried out via a series of experimental measurements. The scale of vertical seawall model was selected by considering the available dimensions of some existing seawalls. The trend of force distribution exerted on the seawall model due to the impact of tsunami bores are characterized by four distinct phases: (1) bore front impact phase, (2) bore run-up the wall phase, (3) redirected or overflow phase, and (4) the quasi-steady phase. In this study, the maximum pressure exerted on the seawall model was recorded at the lowest-located pressure sensor with the value approximately at 8 kPa (Case 5). The maximum force obtained in this study was 2.74 kN (Case 5). The present data also exhibit that the maximum forces exerted on the seawall for all bore depths produced in this study and the empirical formulas by Cross (1967), Fujima et al. (2009), and OCDI (2009) models are quite reliable and the values calculated using these equations came very close to the dataset of the present study.

However, further studies using higher tsunami bore height cases and utilising the entire seawall surface model instrumented with pressure sensors are highly recommended for accurate estimation of the pressures and forces on the seawall subjected to a tsunami.

ACKNOWLEDGEMENTS

Special thanks to Mr. Farid and all MHI NAHRIM technical staffs whom involved in this project for their great assistance during conducting this project. The financial support from Public Service Department Scholarship of Malaysia (JPA) throughout this study is highly appreciated. The first author appreciates the support from NAHRIM for providing the author with access to the facility and full supports during the experiments. This research was partly funded by the Geran Universiti Putra Malaysia, PUTRA GRANT UPM (Grant No. 9443500) and is greatly appreciated.

REFERENCES

- Al-Faesly, T. Q. (2016). *Extreme hydrodynamic loading on near-shore structures* (Doctoral dissertation). University of Ottawa, Canada.
- Asakura, R., Iwase, K., Ikeya, T., Takao, M., Kaneto, T., Fujii, N., & Ohmori, M. (2000). An experimental study on wave force acting on on-shore structures due to overflowing tsunamis. *Proceedings of Coastal Engineering, JSCE, 47*, 911-915.
- Chanson, H. (2006). Tsunami surges on dry coastal plains: application of dam break wave equations. *Coastal Engineering Journal, 48*(4), 355-370.
- Cross, R. H. (1967). Tsunami Surge Forces. *Journal of the Waterways and Harbors Division, 93*(4), 201-234.
- Fujima, K., Achmad, F., Shigihara, Y., & Mizutani, N. (2009). Estimation of tsunami force acting on rectangular structures. *Journal of Disaster Research, 4*(6), 404-409.
- Hamzah, M. A., Mase, H., & Takayama, T. (2001). Simulation and experiment of hydrodynamic pressure on a tsunami barrier. In B. L. Edge (Ed.), *Coastal Engineering 2000* (pp. 1501-1507). Reston: American Society of Civil Engineers.
- Hsiao, S., & Lin, T. (2010). Tsunami-like solitary waves impinging and overtopping an impermeable seawall : Experiment and RANS modeling. *Coastal Engineering, 57*(1), 1-18.
- Kato, F., Inagaki, S., & Fukuhama, M. (2006). Wave force on coastal dike due to tsunami. In J. M. Smith (Ed.), *Coastal Engineering* (pp. 5150-5161). Singapore: World Scientific.
- Kihara, N., Niida, Y., Takabatake, D., Kaida, H., Shibayama, A., & Miyagawa, Y. (2015). Large-scale experiments on tsunami-induced pressure on a vertical tide wall. *Coastal Engineering, 99*, 46-63.
- Lin, T. C., Hwang, K., Hsiao, S., & Yang, R. Y.. (2012). An experimental observation of a solitary wave impingement, run-up and overtopping on a seawall. *Journal of Hydrodynamics, Ser. B, 24*(1), 76-85.
- Mokhtar, Z. A., Mohammed, T. A., Yusuf, B., & Lau, T. L. (2019). Experimental investigation of tsunami bore impact pressure on a perforated seawall. *Applied Ocean Research, 84*, 291-301.
- Nouri, Y., Nistor, I., Palermo, D., & Cornett, A. (2010). Experimental investigation of tsunami impact on free standing structures. *Coastal Engineering Journal, 52*(1), 43-70.
- OCDI . (2009). *Technical Standards and Commentaries for Port and Harbour Facilities in Japan*. Overseas Coastal Area Development Institute of Japan.
- Robertson, I. N., Paczkowski, K., Riggs, H. R., & Mohamed, A. (2013). Experimental Investigation of Tsunami Bore Forces on Vertical Walls. *Journal of Offshore Mechanics and Arctic Engineering, 135*(2), 021601.
- Shafiei, S., Melville, B. W., & Shamseldin, A. Y. (2016). Experimental investigation of tsunami bore impact force and pressure on a square prism. *Coastal Engineering, 110*, 1-16.